

Comosum: An Extensible, Reconfigurable, and Fault-Tolerant IoT Platform for Digital Agriculture

Gloire Rubambiza, Shiang-Wan Chin, Sachille Atapattu, Mueed Rehman,
José F. Martínez, Hakim Weatherspoon

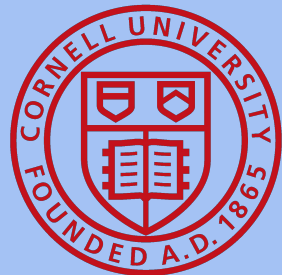

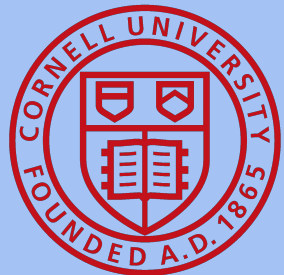

Gloire Rubambiza

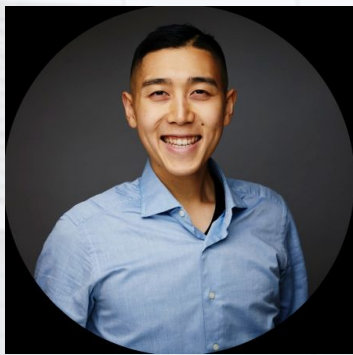

Shiang-Wan Chin



Sachille Atapattu



Mueed Rehman



José F. Martínez



Hakim Weatherspoon

Comosum Technical Contributions

4 Years

18 months

**1M+ sensor
readings**

- Distilled black-box SOTA down to a single interface
- Applied strong systems approaches to new contexts
- Deployed across different farm types and cloud providers

The background of the slide is a photograph of a building with a grey roof and light-colored walls, viewed through a chain-link fence. The fence's grid pattern is prominent over the entire image. The building has a gabled roof and a large window or door area. The overall scene is somewhat desaturated and has a slightly grainy texture.

Background

DA Challenges & State of the art

Comosum Design & Implementation

Deployment Experiences, Insights & Limitations

Conclusion

What is Digital Agriculture (DA)?

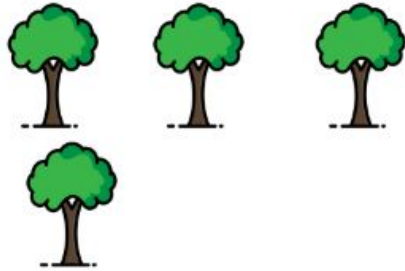
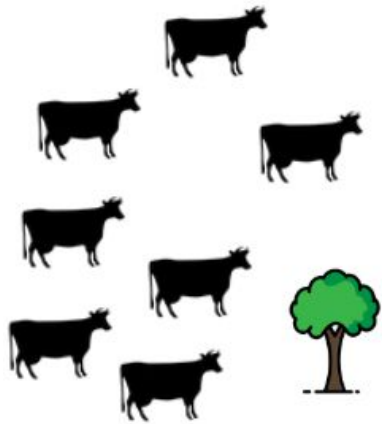

Growing ability to... convert precise data...
into actionable knowledge to ... support
complex decision-making on farms

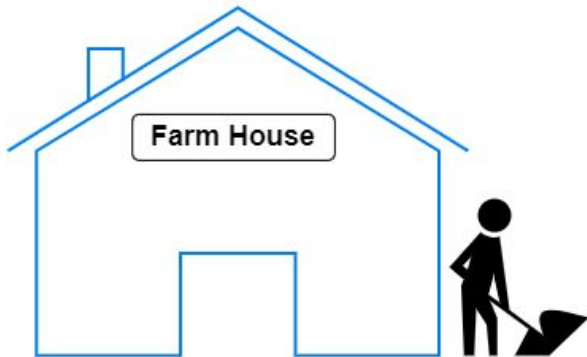

Priorities for Science to Overcome Hurdles Thwarting the Full Promise of the 'Digital Agriculture' Revolution. Shepherd *et al.* 2018

What is Digital Agriculture (DA)?

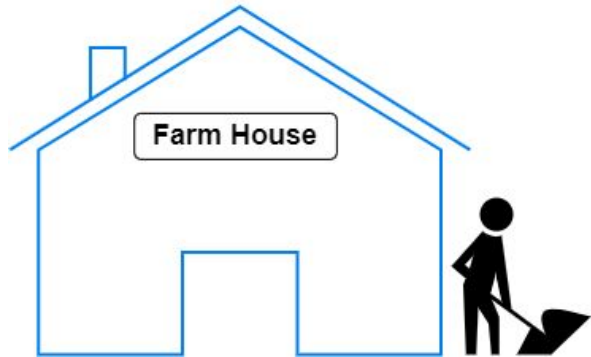
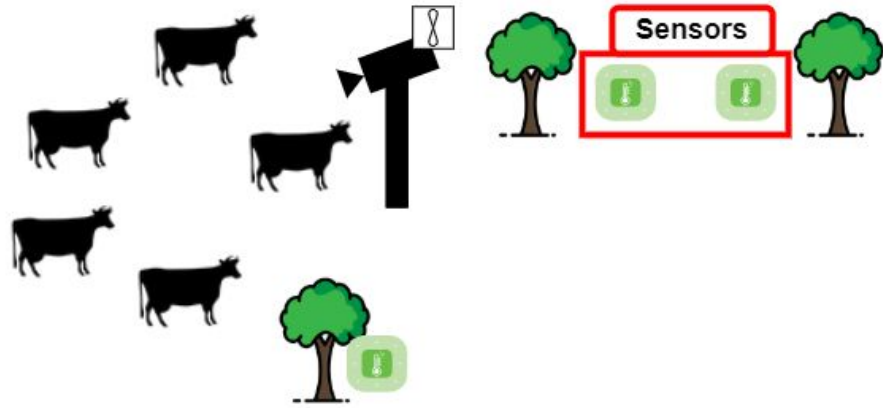

What is Digital Agriculture (DA)?

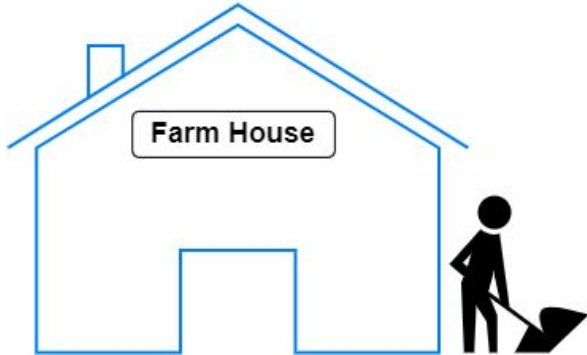
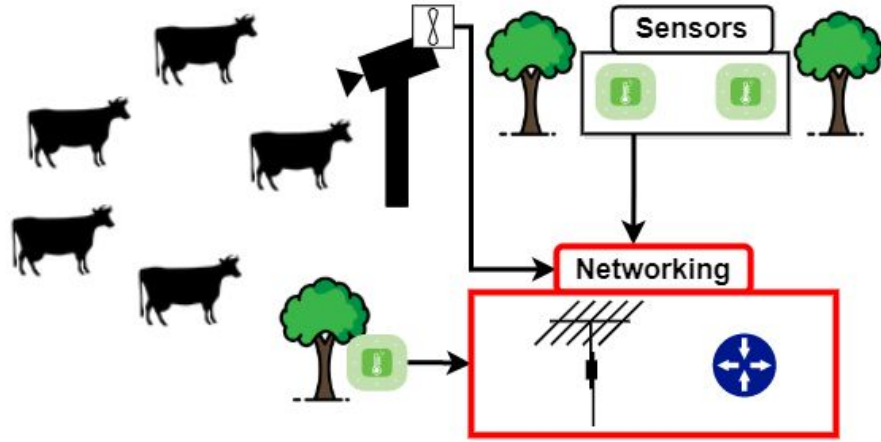

What is Digital Agriculture (DA)?

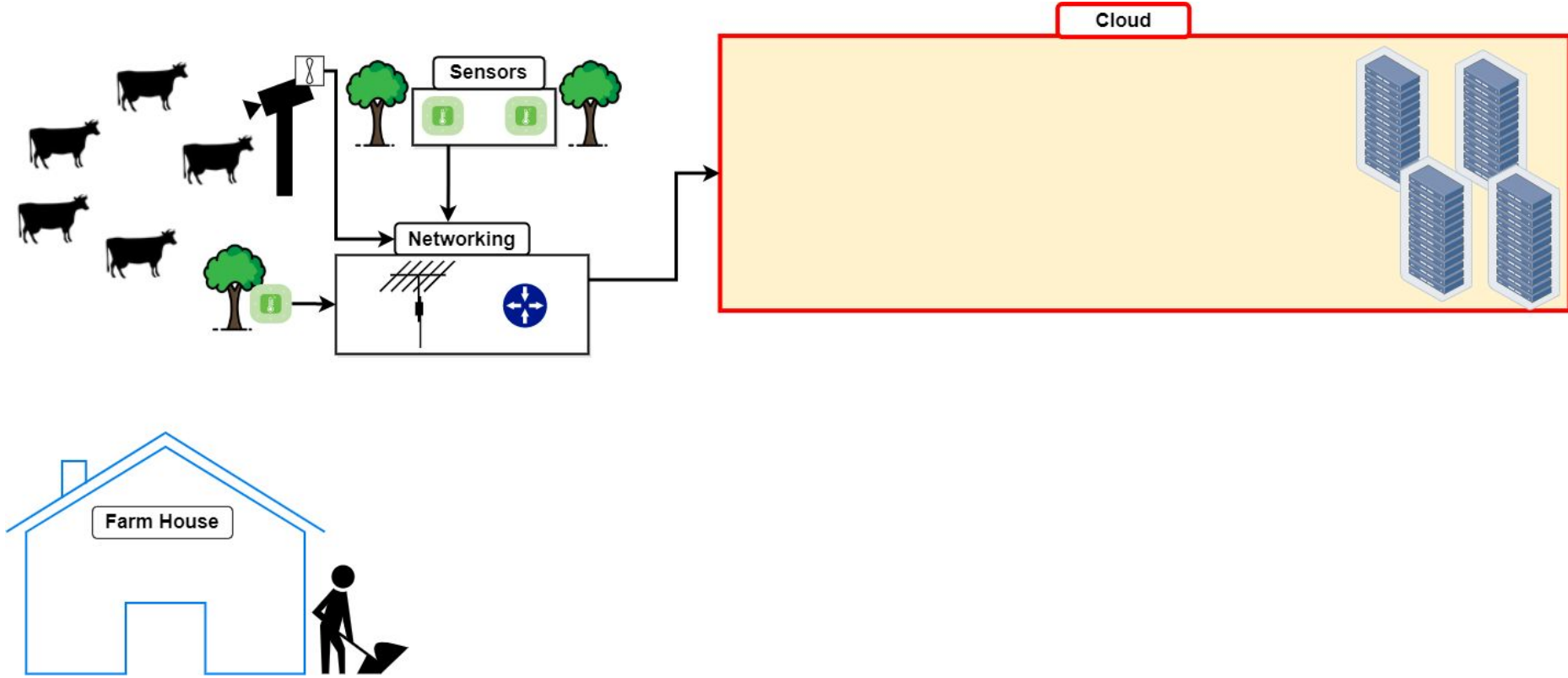

What is Digital Agriculture (DA)?

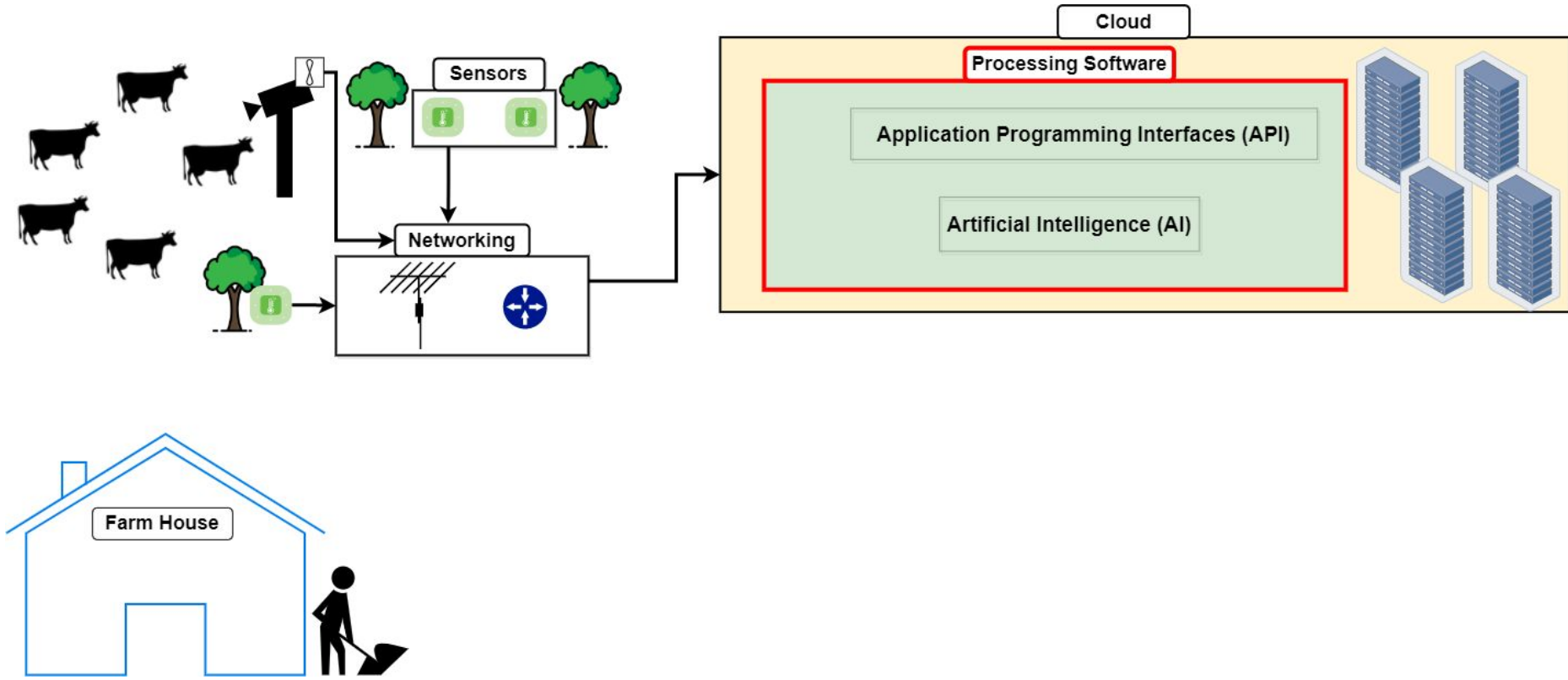

What is Digital Agriculture (DA)?

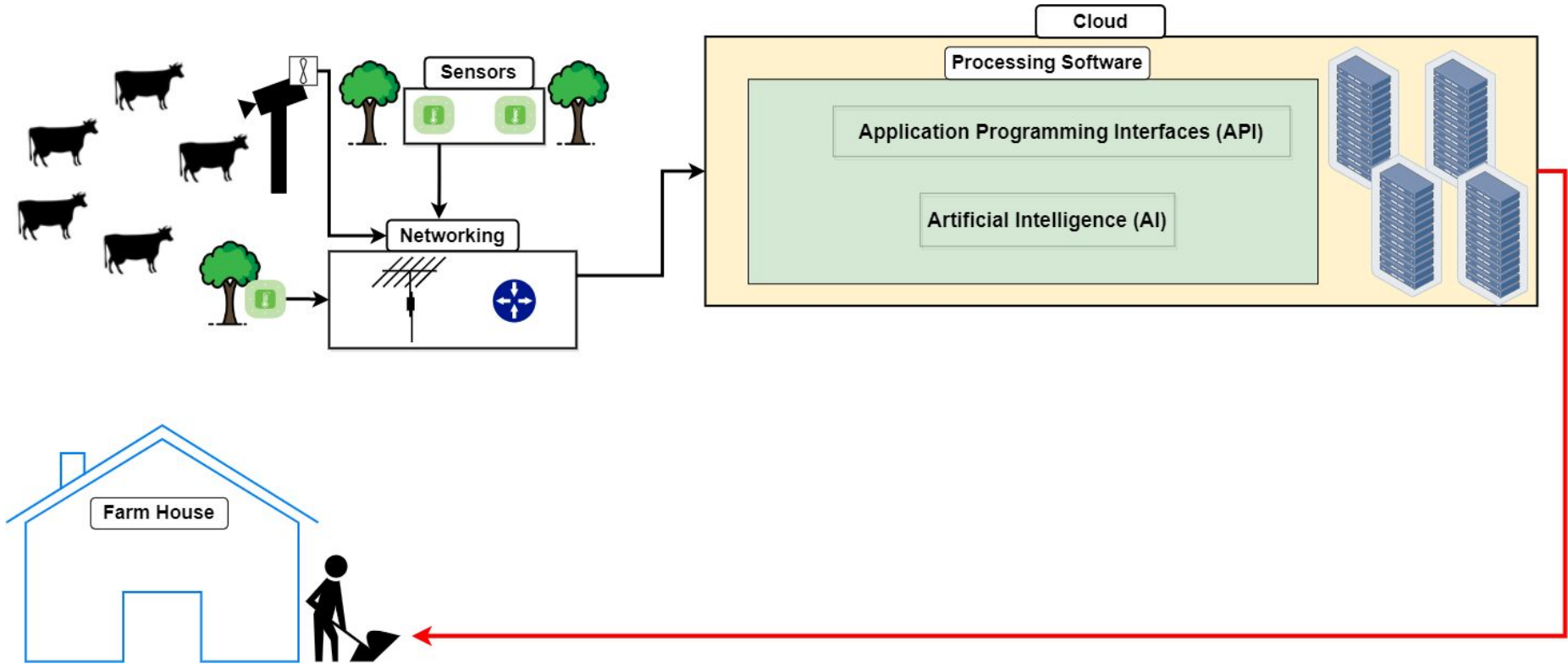

A faded background image showing a building with a gabled roof and a chain-link fence in the foreground. The text is overlaid on the left side of the image.

Background

DA Challenges & State of the art

Comosum Design & Implementation

Deployment Experiences, Insights & Limitations

Conclusion

Motivating Challenges in DA

Greenhouse: KB/hour



Motivating Challenges in DA

Greenhouse: KB/hour



Dairy Farm: MB/day

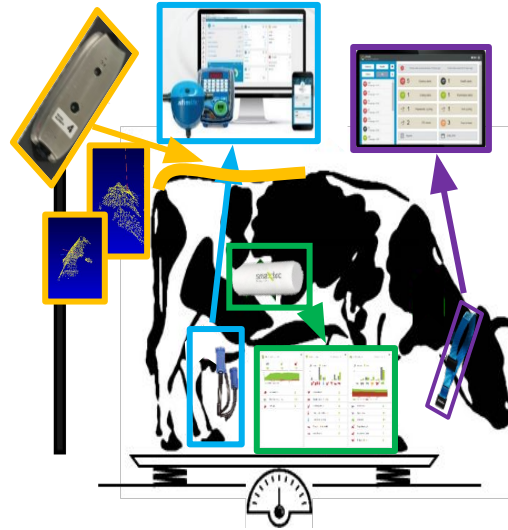

Image Credit: Martin Perez

Rural Infrastructure Challenges

- Sparse population & geography
 - Internet connectivity
 - Public transportation
 - Power

Rural Infrastructure Challenges

- Sparse population & geography
- Scale & distance limit access to:
 - Provider maintenance and repair
 - Repair parts for self-repair

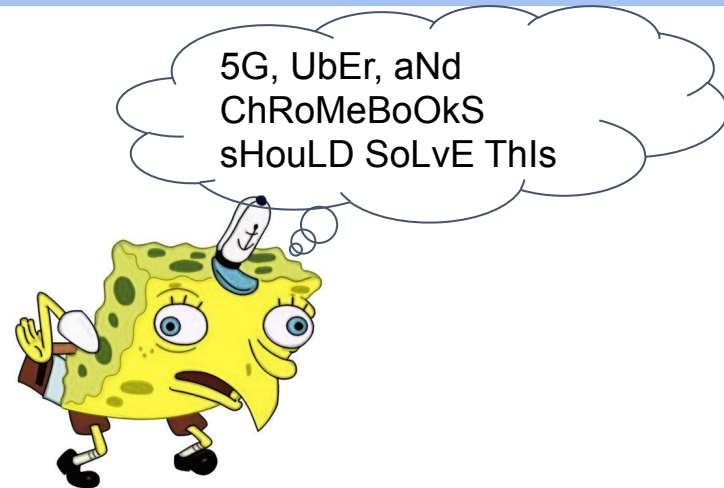

Image Credit: <https://knowyourmeme.com/memes/mocking-spongebob>

Rural Infrastructure Challenges

- Sparse population & geography
- Scale & distance
- Service provider tactics lead to:
 - Closed system and manuals
 - Reselling sensor data and resulting insights

Rural Infrastructure Challenges

- Sparse population & geography
- Scale & distance
- Vendor lock-in

Research Question:

How do we build **data-intensive** IoT apps on top of **unreliable** rural infrastructure?

Infrastructure Challenges → Desired Technical Features

- Sparse population & geography →
 - Reconfigurable networks
 - Energy efficiency
- Scale & distance →
 - Fault tolerance
 - Failure detection
 - Independent failures
 - Off-the-shelf (OTS) parts
- Vendor lock-in →
 - Open-source X-ware
 - Accessible data analytics

A faded background image showing a building with a gabled roof and a chain-link fence in the foreground. The text is overlaid on the left side of the image.

Background

DA Challenges & State of the art

Comosum Design & Implementation

Deployment Experiences, Insights & Limitations

Conclusion

State of the art: Sensing

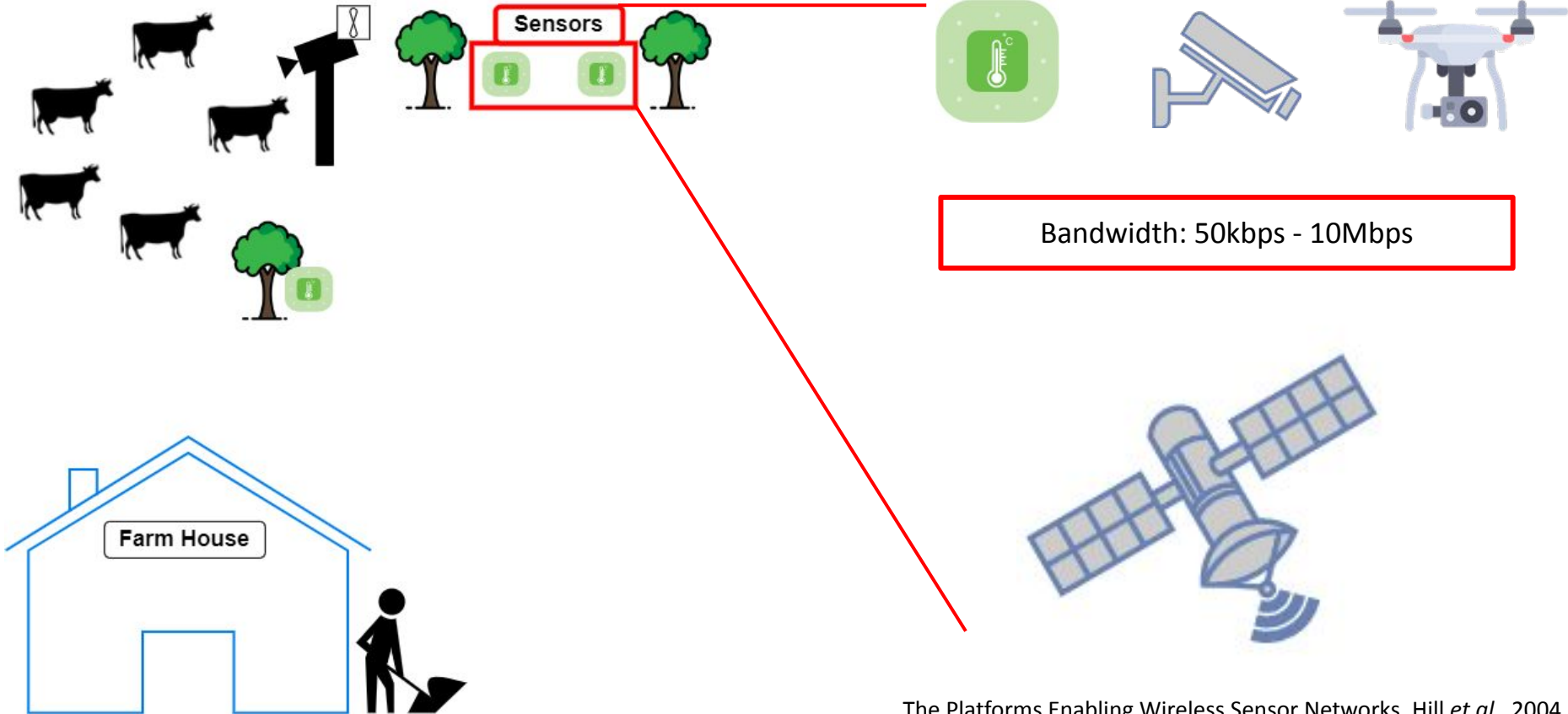

State of the art: Sensing

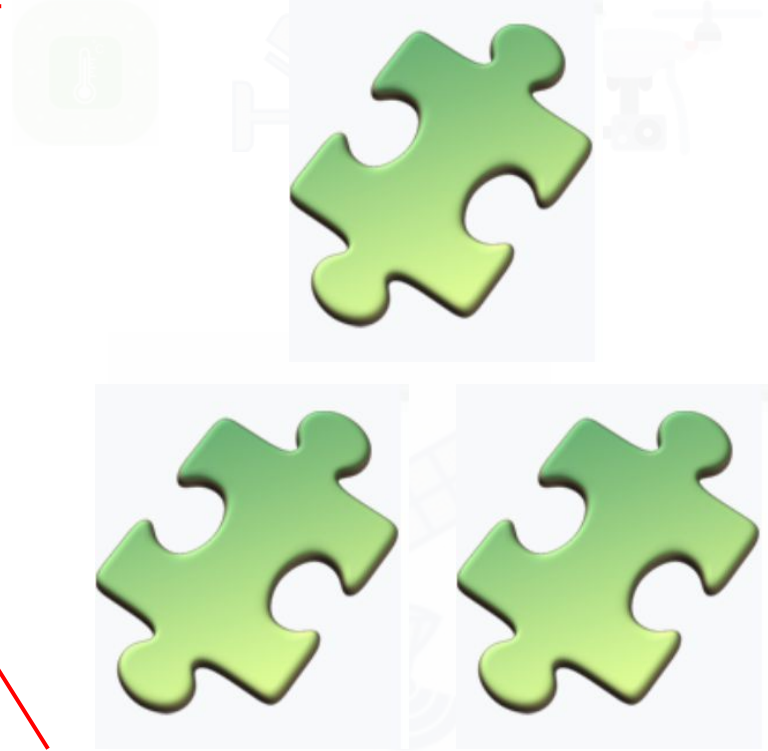
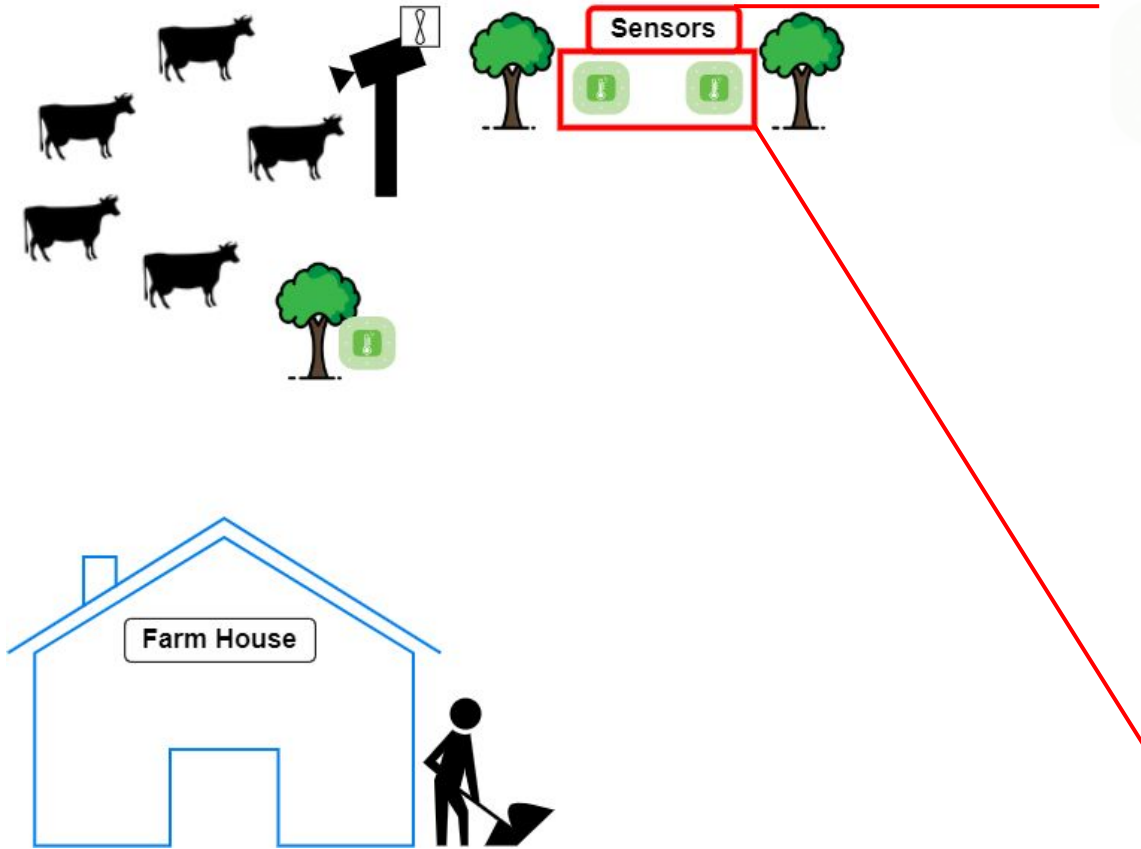

State of the art: Cloud computing

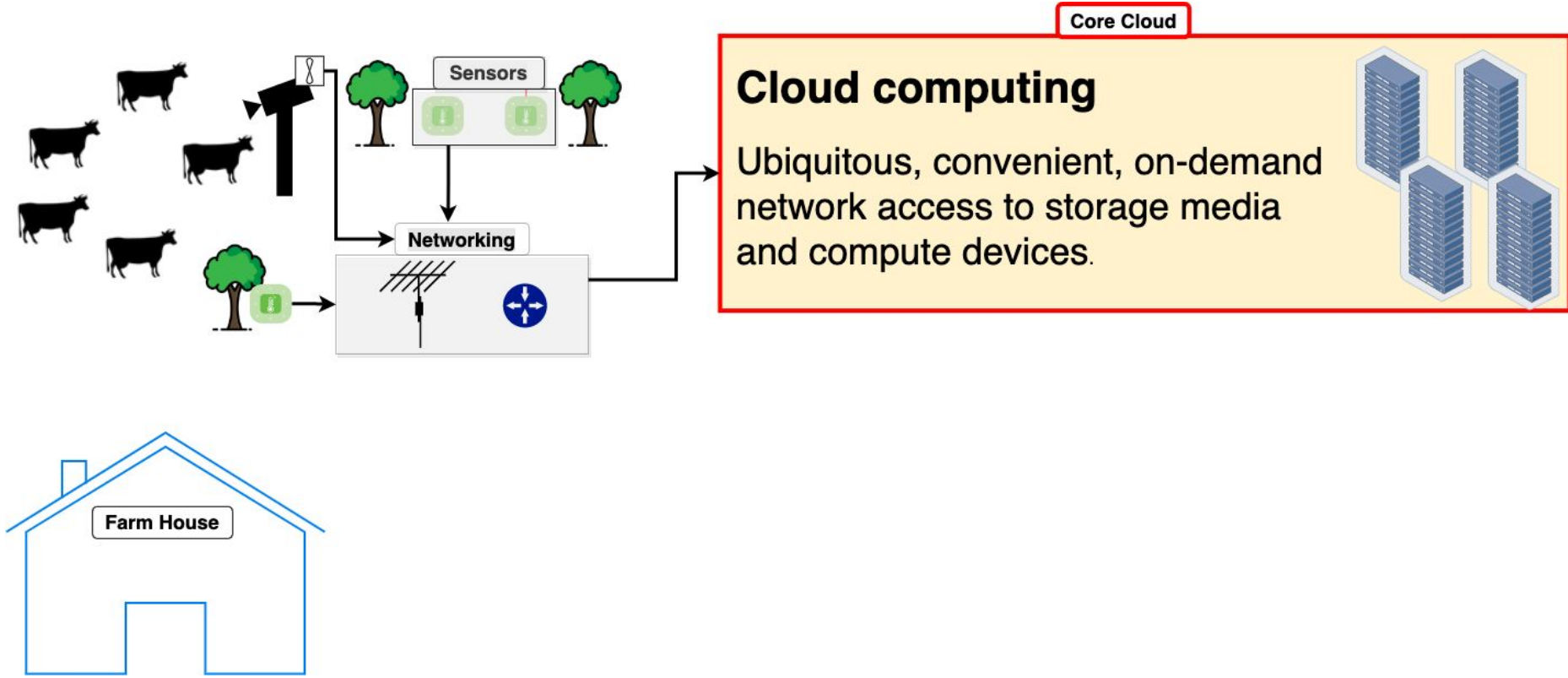

State of the art: Edge computing

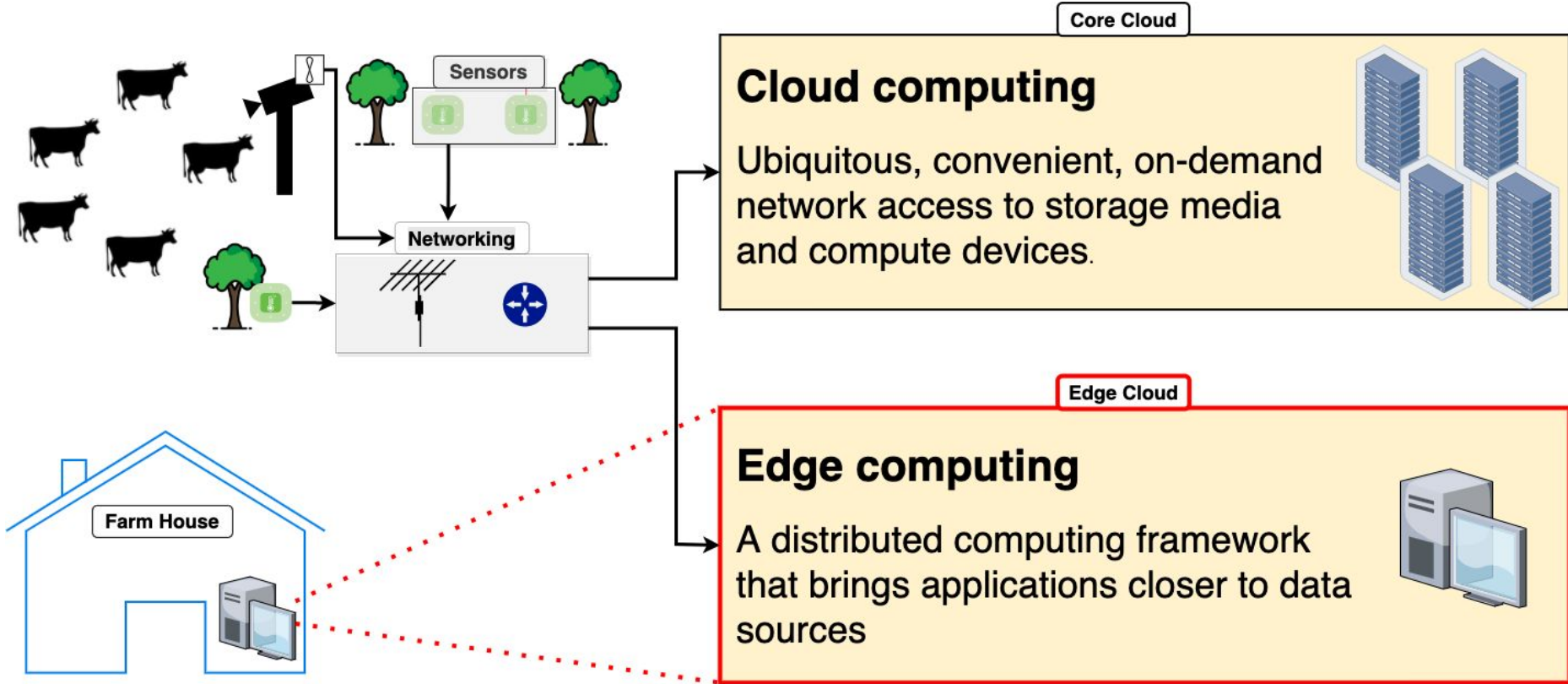

The distributed cloud avoids vendor lock-in

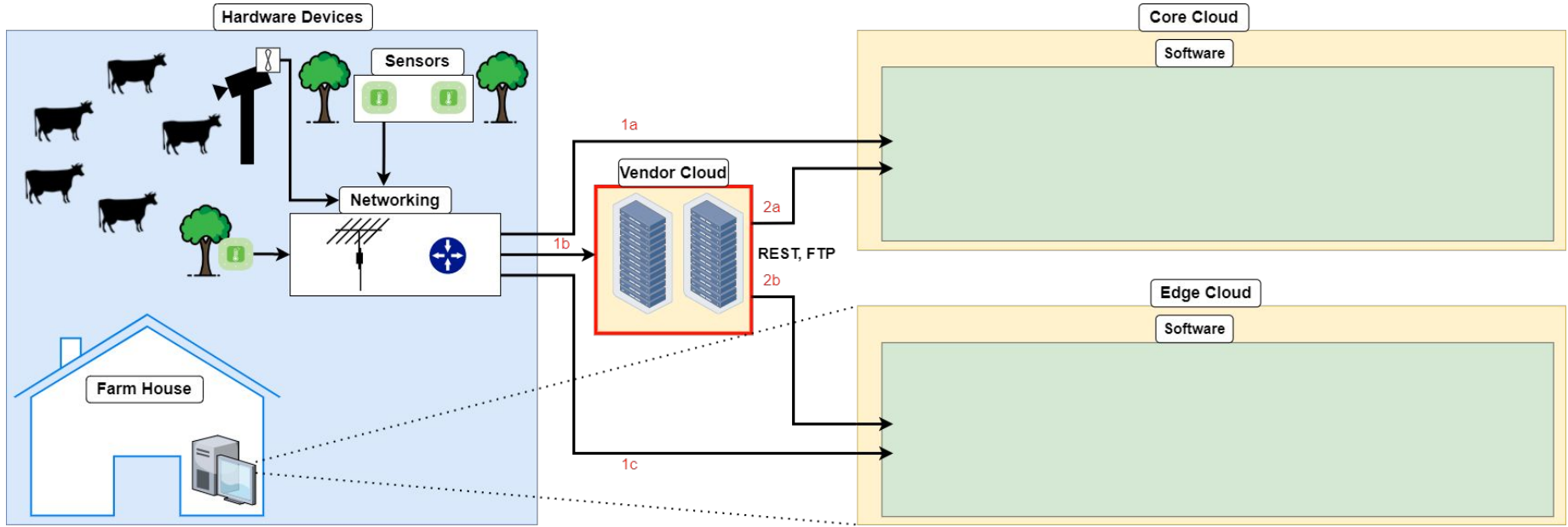

Revised Research Question:

How do we build an *extensible*,
reconfigurable, and *fault tolerant* IoT
platform on top of **unreliable** base
infrastructure?

Building Comosum on unreliable base infrastructure

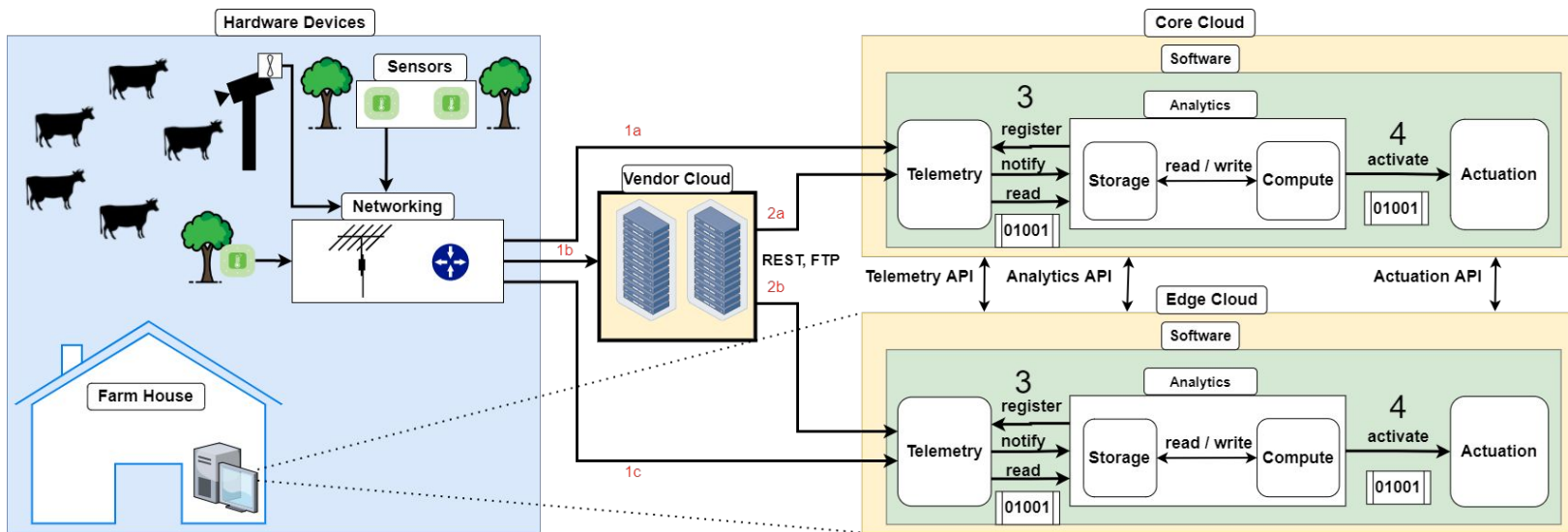

Research Contribution: Design, implementation, and deployments of a reconfigurable platform for DA experimentation

A faded background image showing a building with a gabled roof and a chain-link fence in the foreground. The text is overlaid on the left side of the image.

Background

DA Challenges & State of the art

Comosum Design & Implementation

Deployment Experiences, Insights & Limitations

Conclusion



Backyard deployment
Oct 2020



TVWS config
Mar 2021



Dairy farm visit
Feb 2023

Comosum Design aka The Software Defined Farm (SDF)

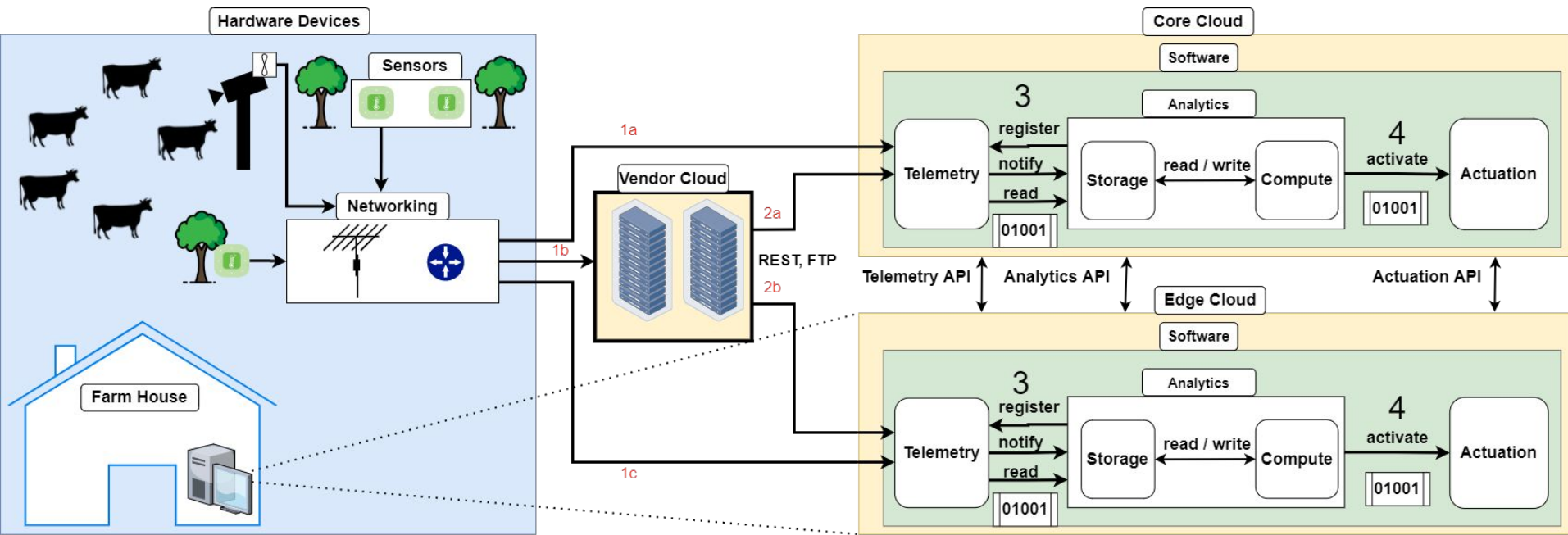

Comosum Design: Telemetry Module

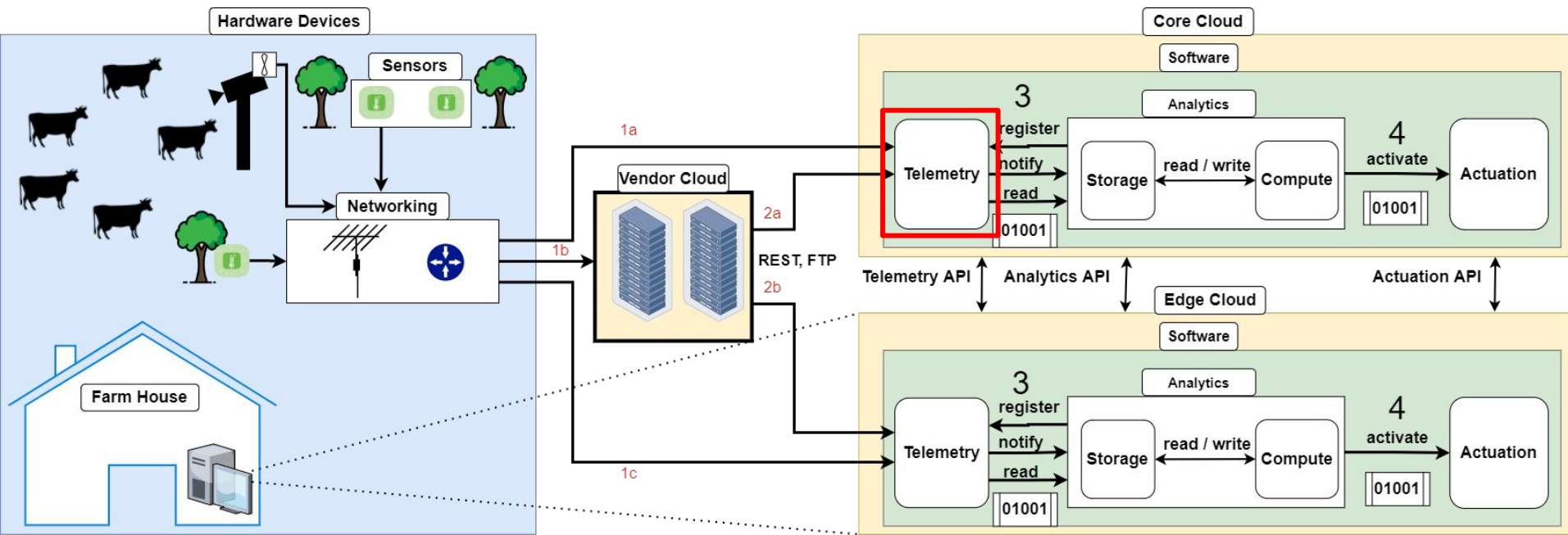

Comosum Design: The Analytics Module

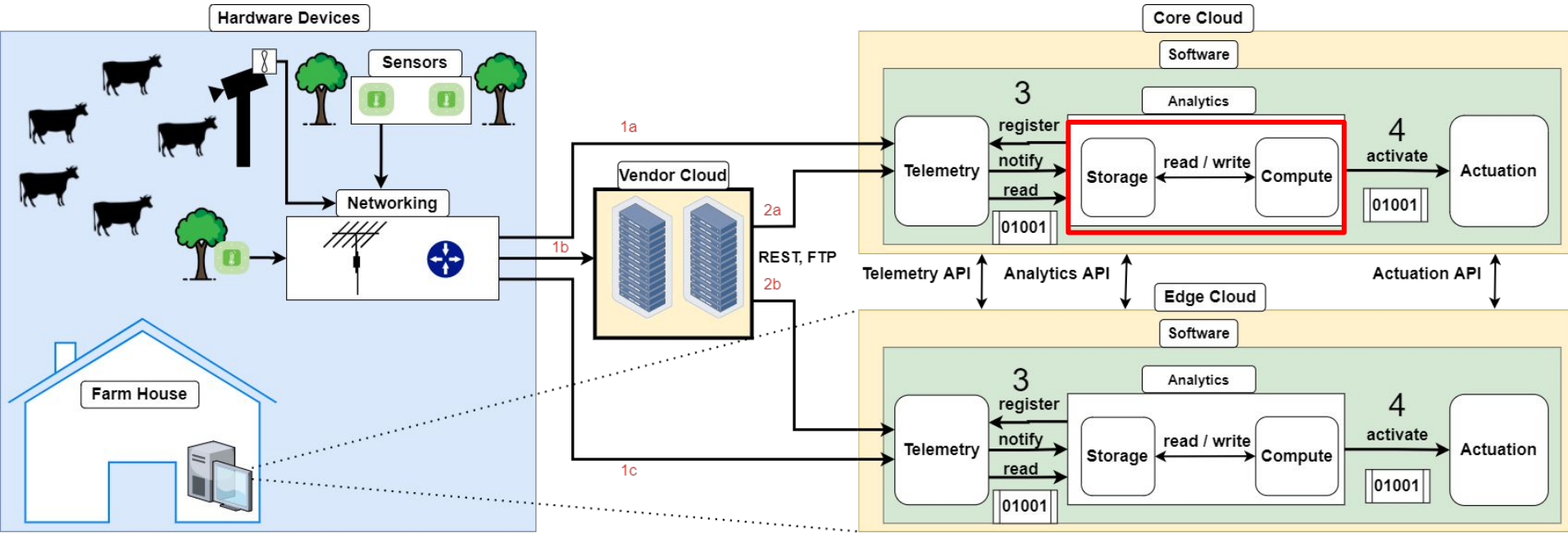

Comosum Design: The Actuation Module

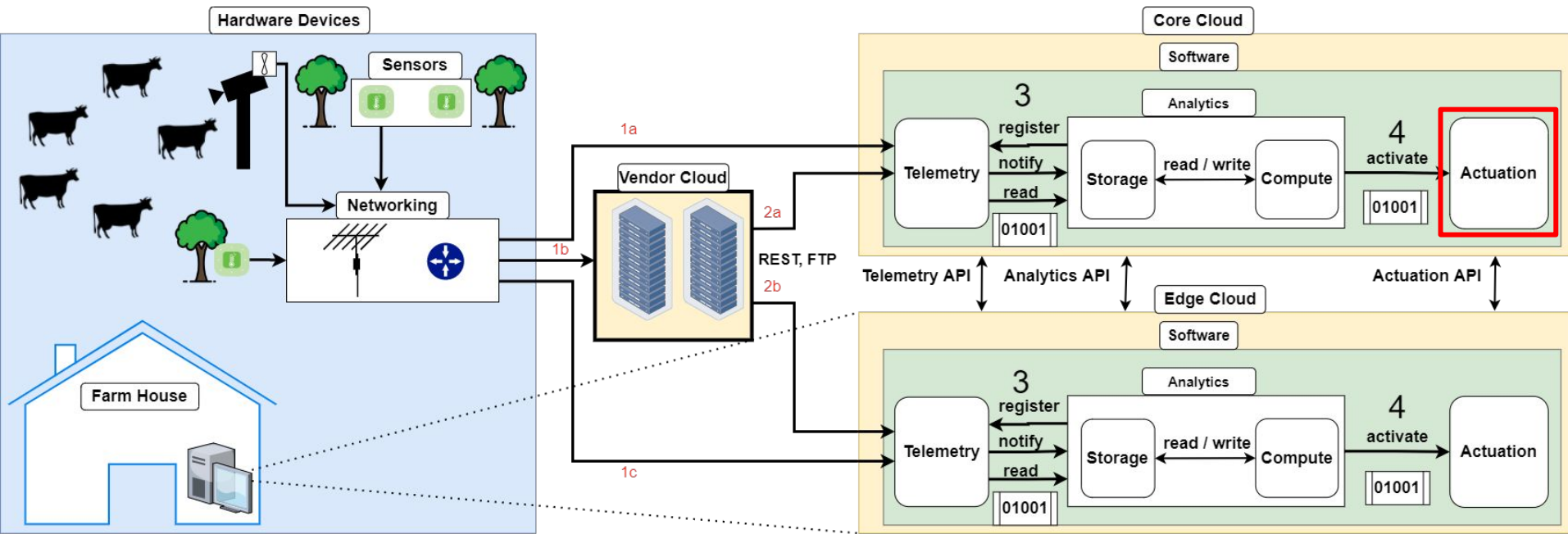

Comosum Design: Reconfigurable Control Plane

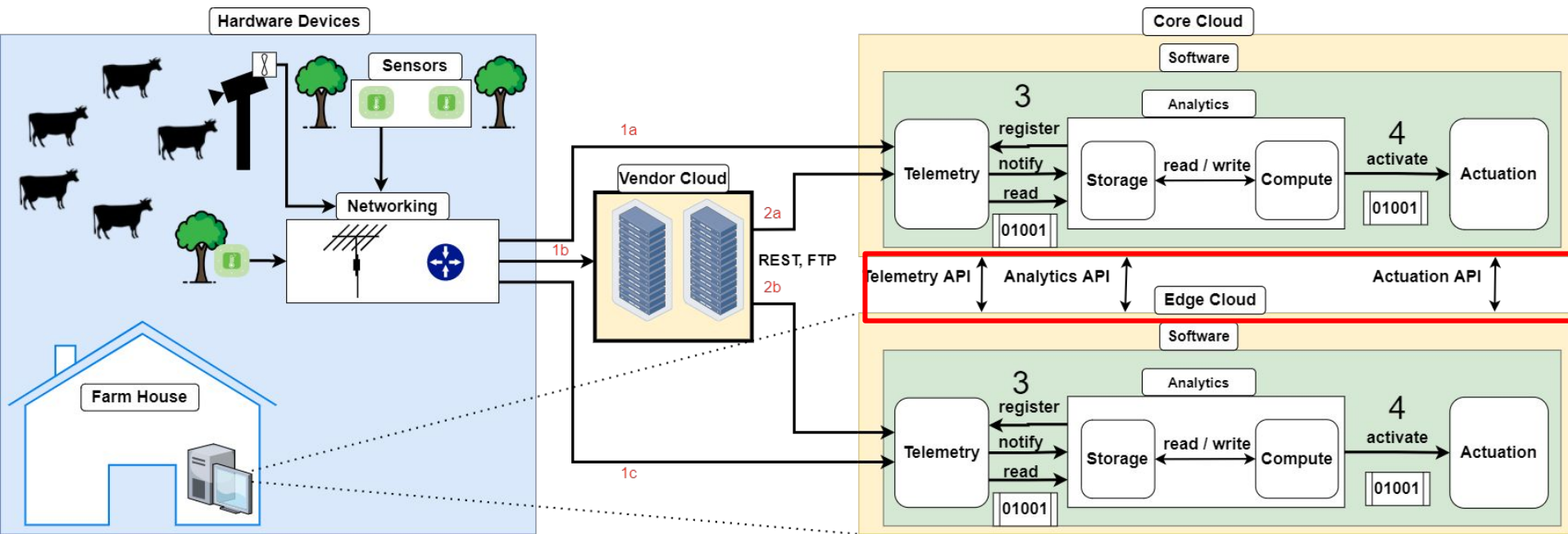

FarmBIOS: A Comosum Implementation

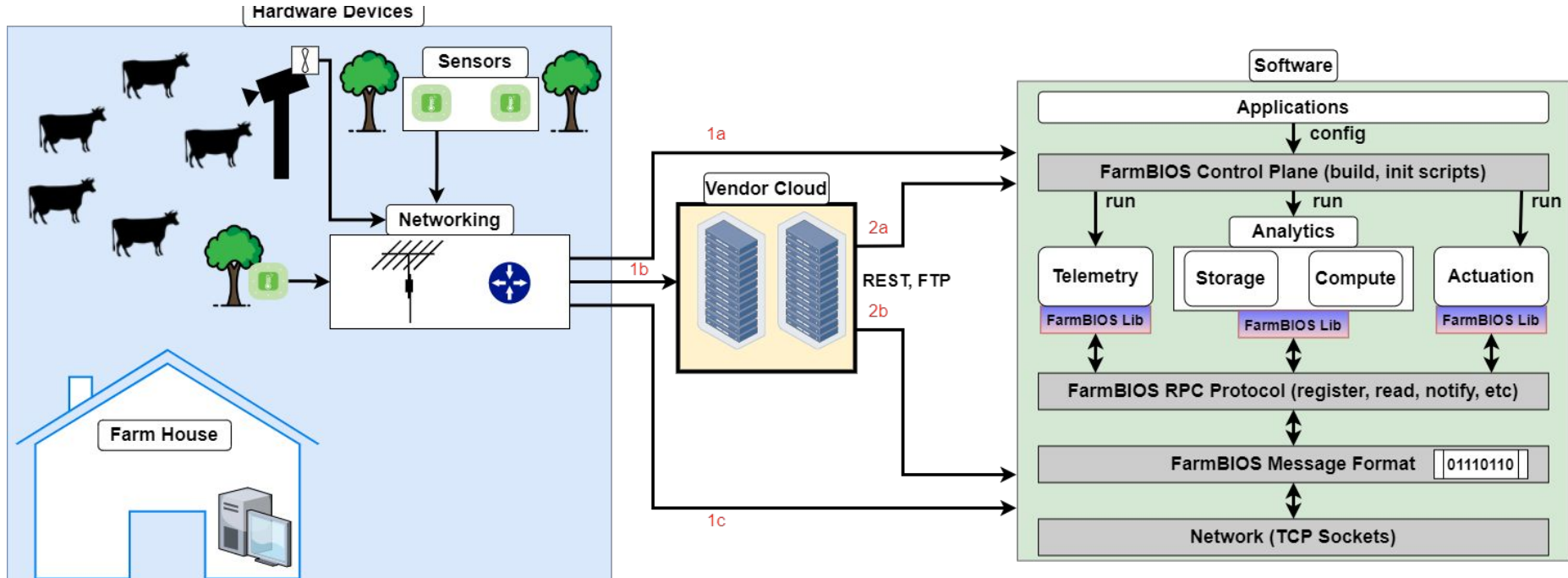

FarmBIOS: A Comosum Implementation

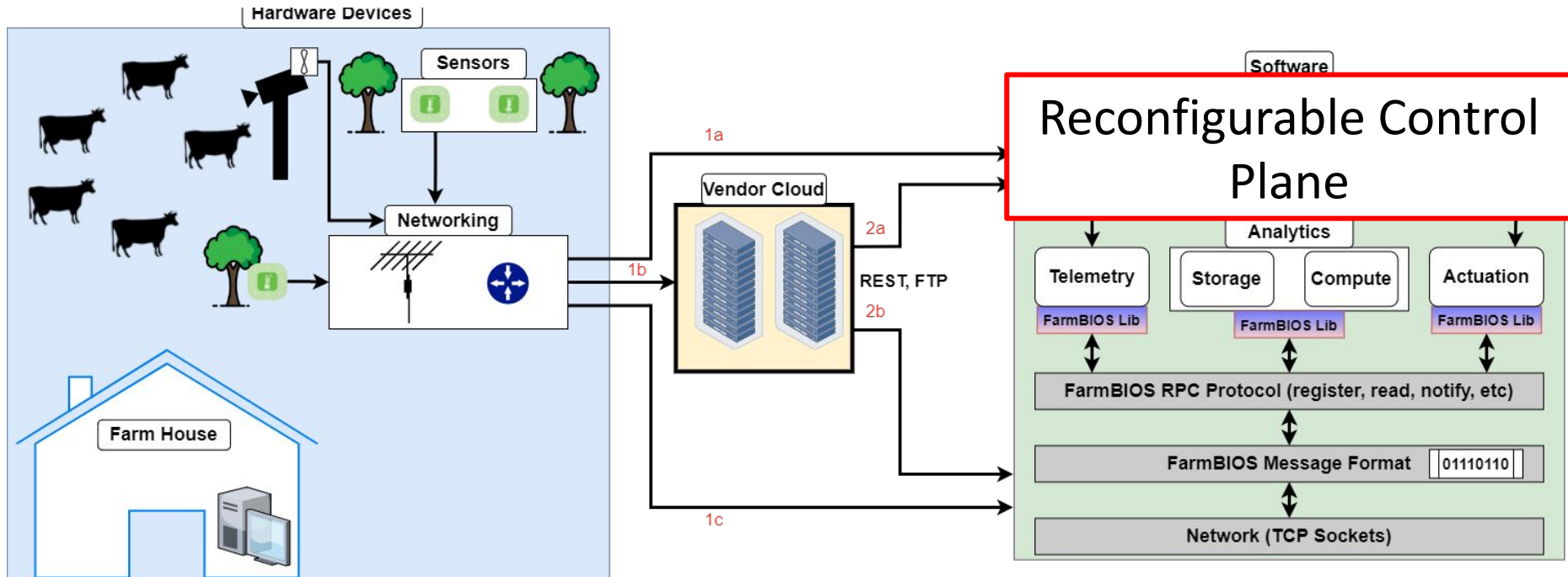

FarmBIOS: A Comosum Implementation

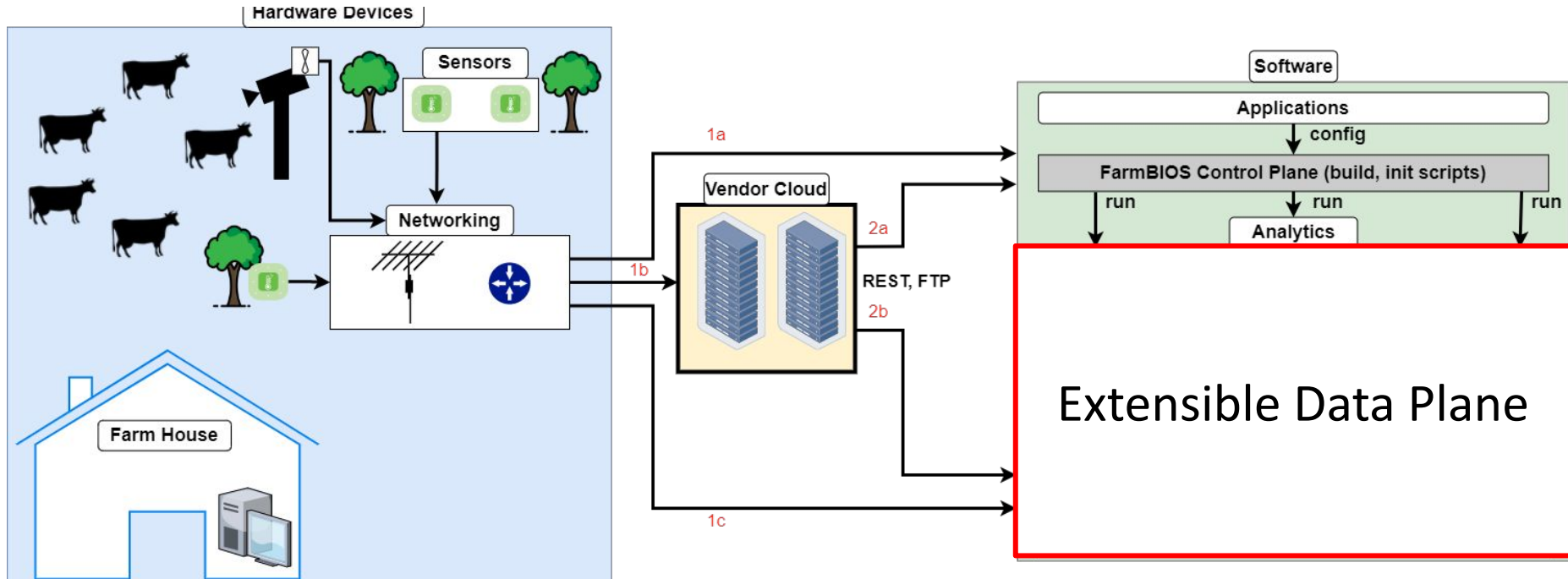

FarmBIOS: A Comosum Implementation

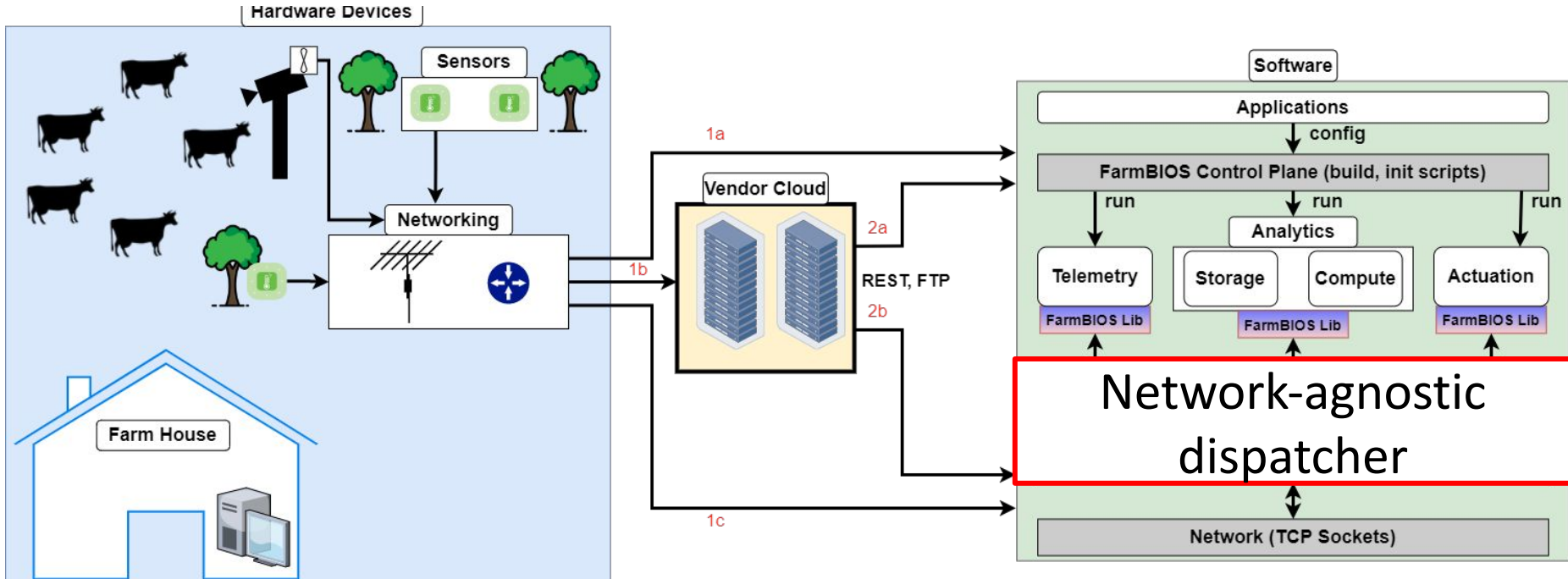

A faded background image showing a building with a gabled roof and a chain-link fence in the foreground. The text is overlaid on the left side of the image.

Background

DA Challenges & State of the art

Comosum Design & Implementation

Deployment Experiences, Insights & Limitations

Conclusion

FarmBIOS Applications

WaterGuard



CowsOnFitbits

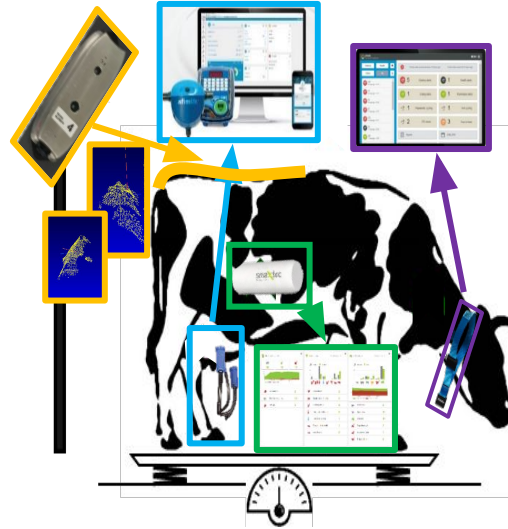

Image Credit: Martin Perez

WineGuard

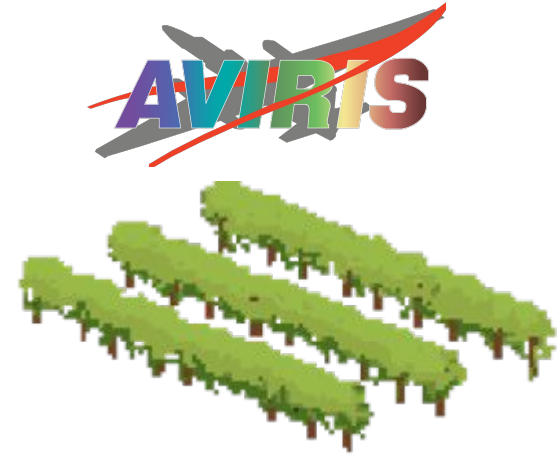
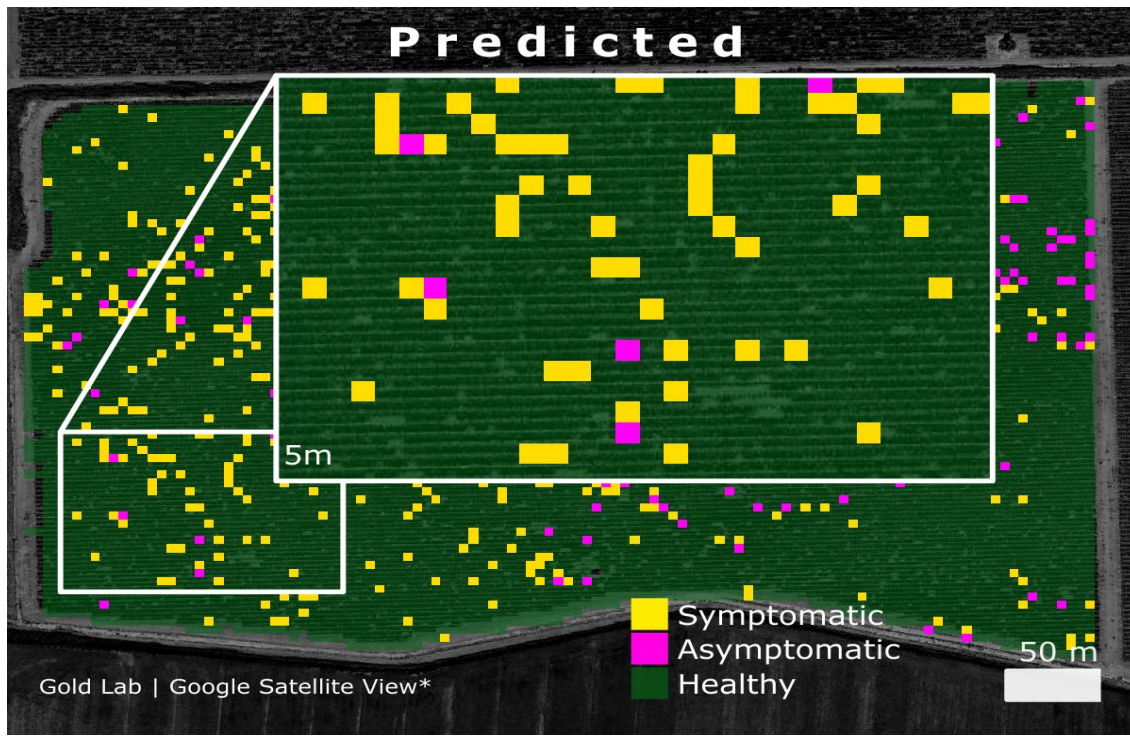

Image Credit: Fernando Romero Galvan

FarmBIOS Deployments: WineGuard



Training	Data Location	Data Size	Compute	Storage	Runtime	Accuracy
Edge	Local	4MB	8 CPUs	256GB	27.1s	82%
Edge	Cloud	-	8 CPUs	256GB	35.6s	84%
Azure ML	Cloud	-	2 vCPUs	100GB	86.5s	84%

FarmBIOS Deployments: WaterGuard

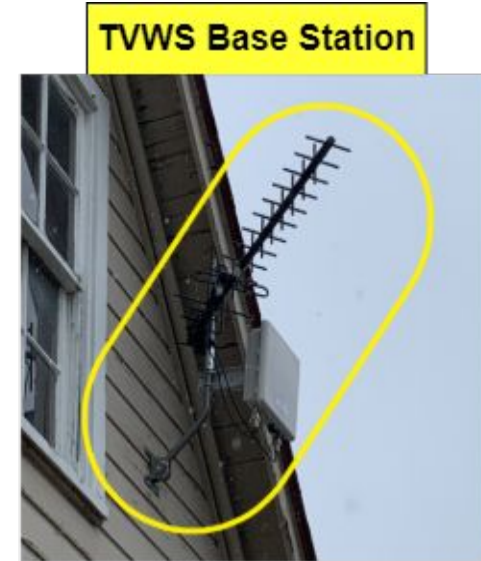
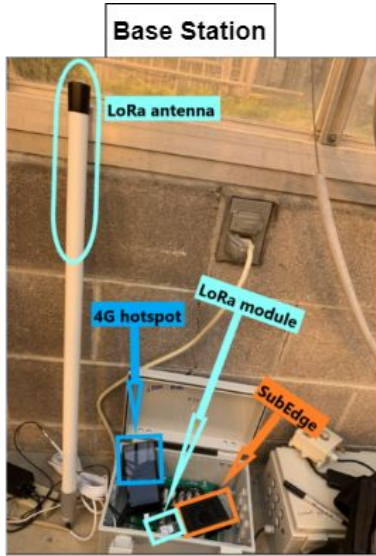

9 sensors hubs

1 **TVWS** client/base station

2 **LoRa** antennas

2 Edge devices (4GB RAM, 32GB storage)

FarmBIOS Deployments: WaterGuard

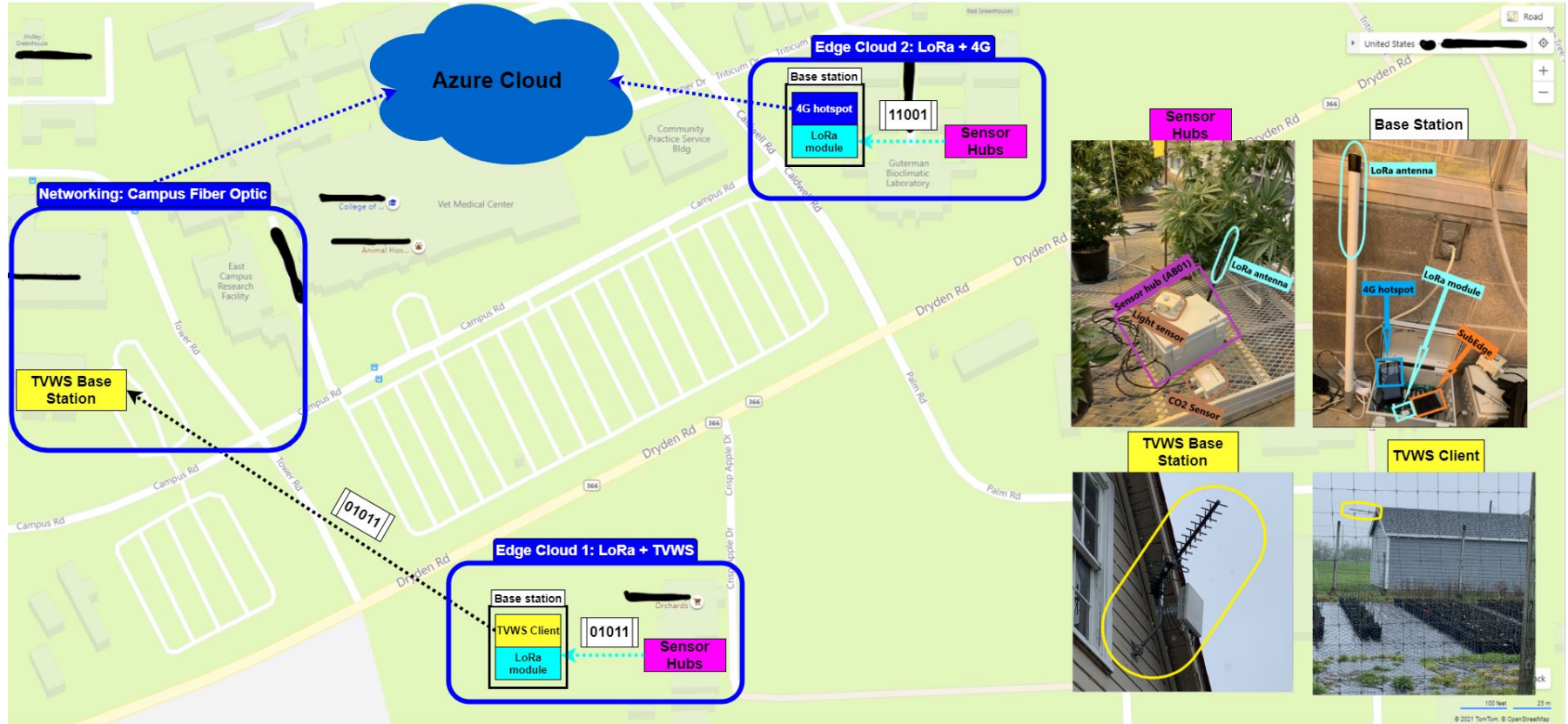

Adapting to the wild: offline data collection

Total deployment: **18 months**
Average deployment: **223 days**
1M+ sensor readings

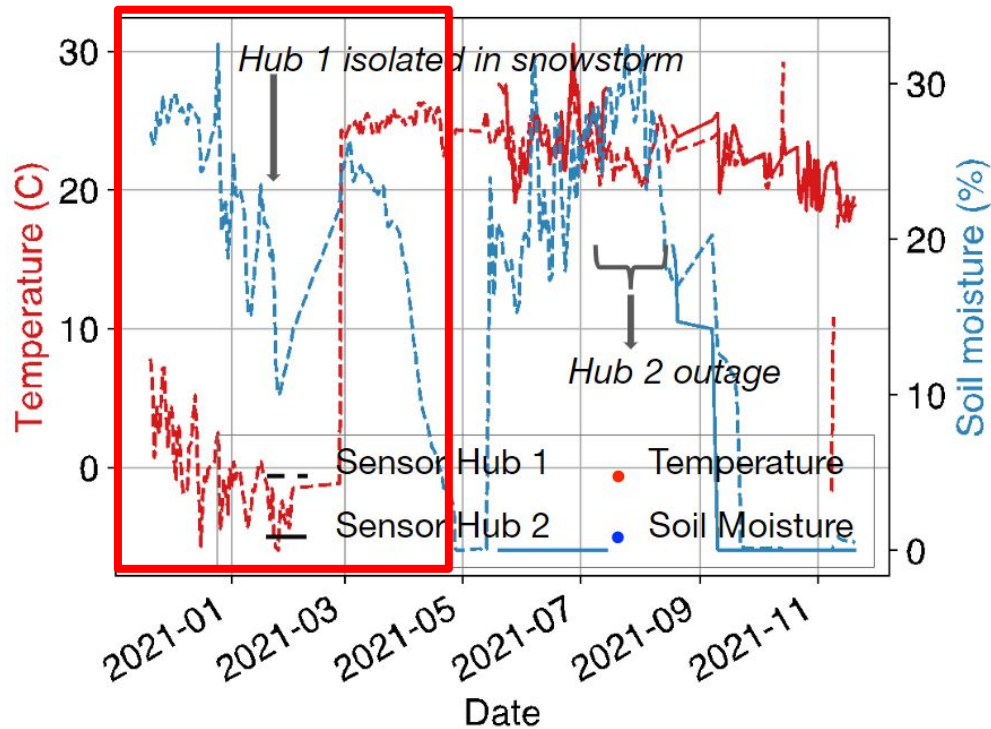

Adapting to the wild: faulty sensors and human errors

Faulty sensors and config errors affect data analytics

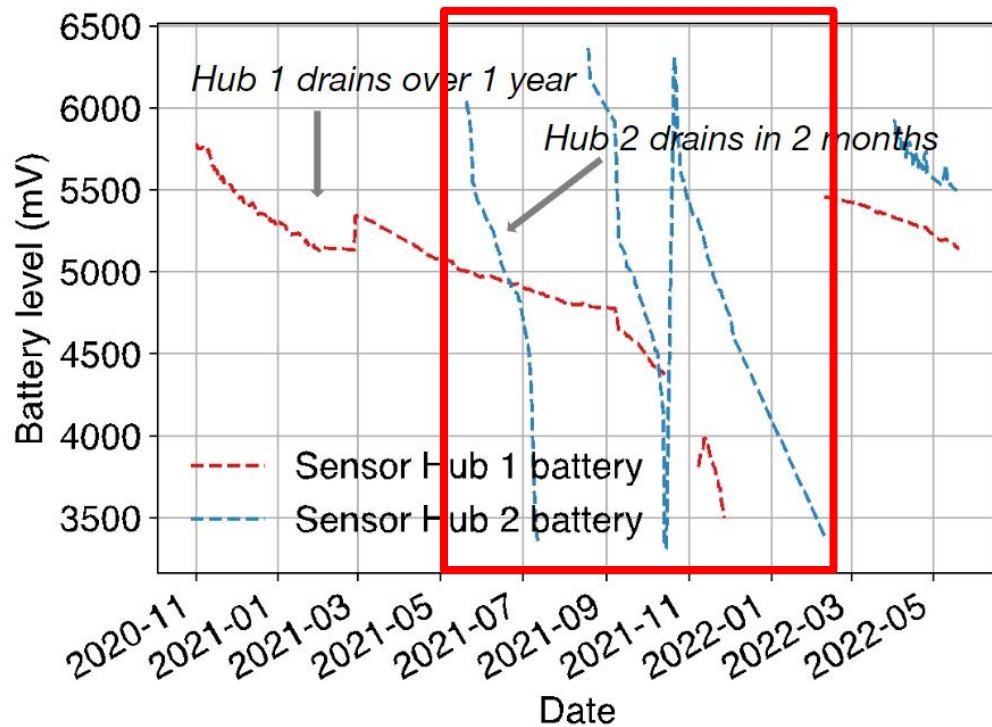

Adapting to the wild: active digital twin

Active digital twin notifies human operators if a sensor hub twin diverges from its physical twin

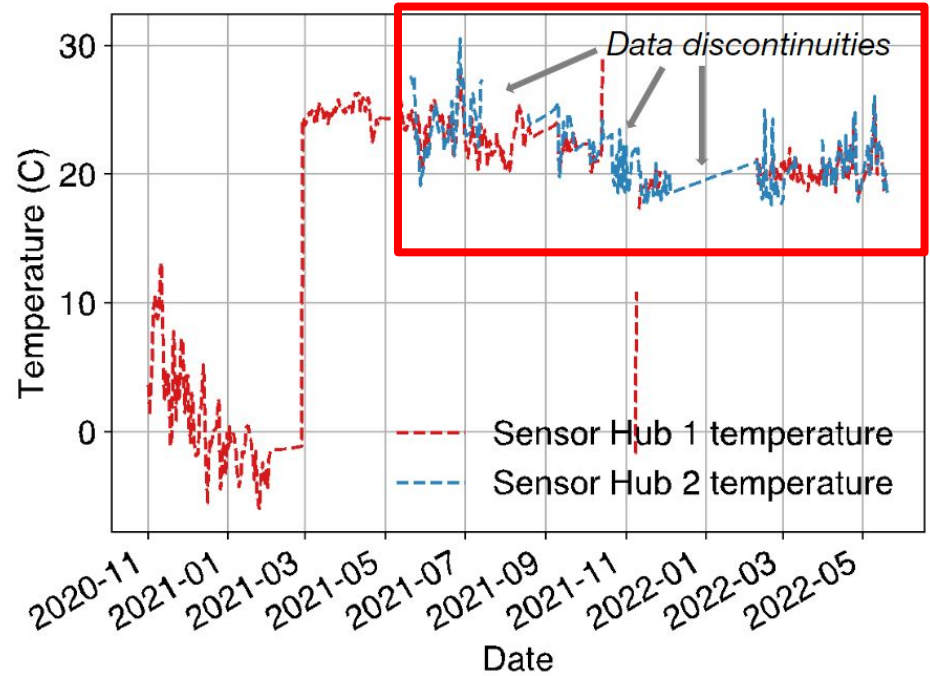

Adapting to the wild: active digital twin

Active digital twin notifies human operators if a sensor hub twin diverges from its physical twin



A faded background image showing a building with a gabled roof and a chain-link fence in the foreground. The text is overlaid on the left side of the image.

Background

DA Challenges & State of the art

Comosum Design & Implementation

Deployment Experiences, **Insights & Limitations**

Conclusion

Practical Insights & Limitations

- **Extending to new vendors comes with minor costs**
 - **New scripts for each vendor (50 LoCs)**

Practical Insights & Limitations

- Extending to new vendors comes with minor costs
 - New scripts for each vendor (50 LoCs)
- **The cloud complicates reconfigurability**
 - **Treat incoming parameters as abstract data types (ADTs)**

Practical Insights & Limitations

- Extending to new vendors comes with minor costs
 - New scripts for each vendor (50 LoCs)
- The cloud complicates reconfigurability
 - Treat incoming parameters as abstract data types (ADTs)
- **Failure in DA is the norm, not the exception**
 - **Active digital twins detect divergence**

Practical Insights & Limitations

- Extending to new vendors comes with minor costs
 - New scripts for each vendor (50 LoCs)
- The cloud complicates reconfigurability
 - Treat incoming parameters as abstract data types (ADTs)
- Failure in DA is the norm, not the exception
 - Active digital twins detect divergence
- **No automated migrations during permanent outages**
 - **Future work**

A faded background image showing a building with a gabled roof and a chain-link fence in the foreground. The text is overlaid on the left side of the image.

Background

DA Challenges & State of the art

Comosum Design & Implementation

Deployment Experiences, Insights & Limitations

Conclusion

Comosum aka The Software Defined Farm (SDF)

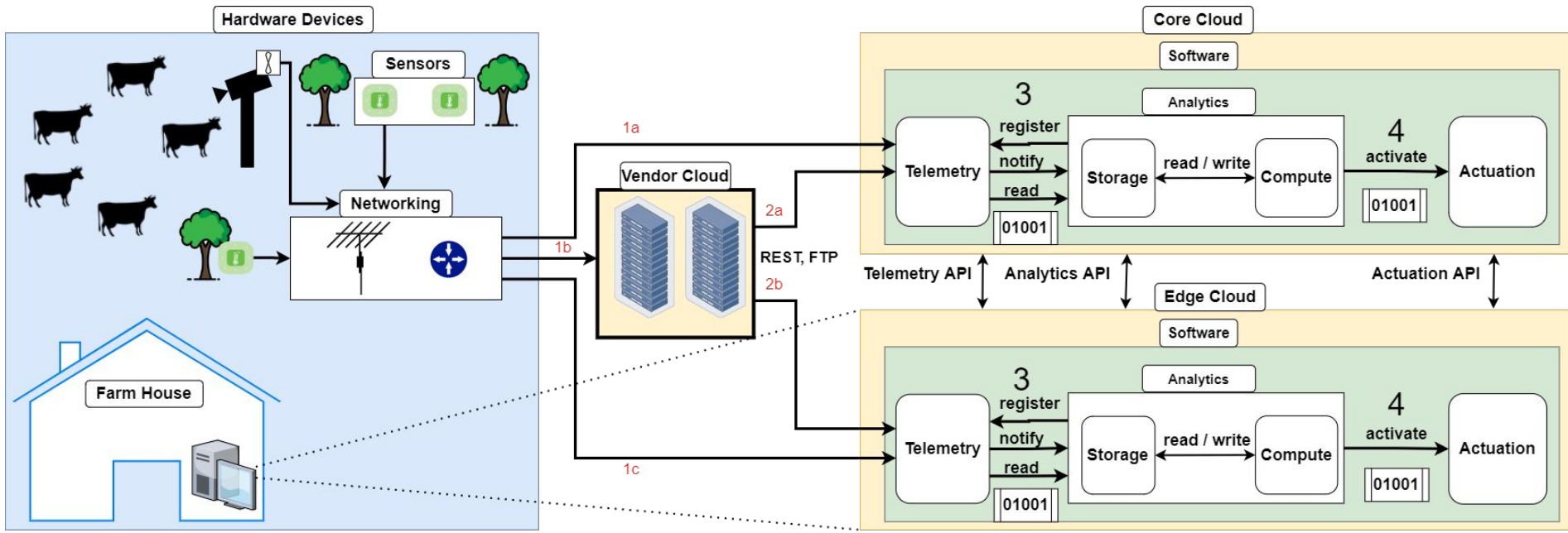

Comosum Technical Contributions

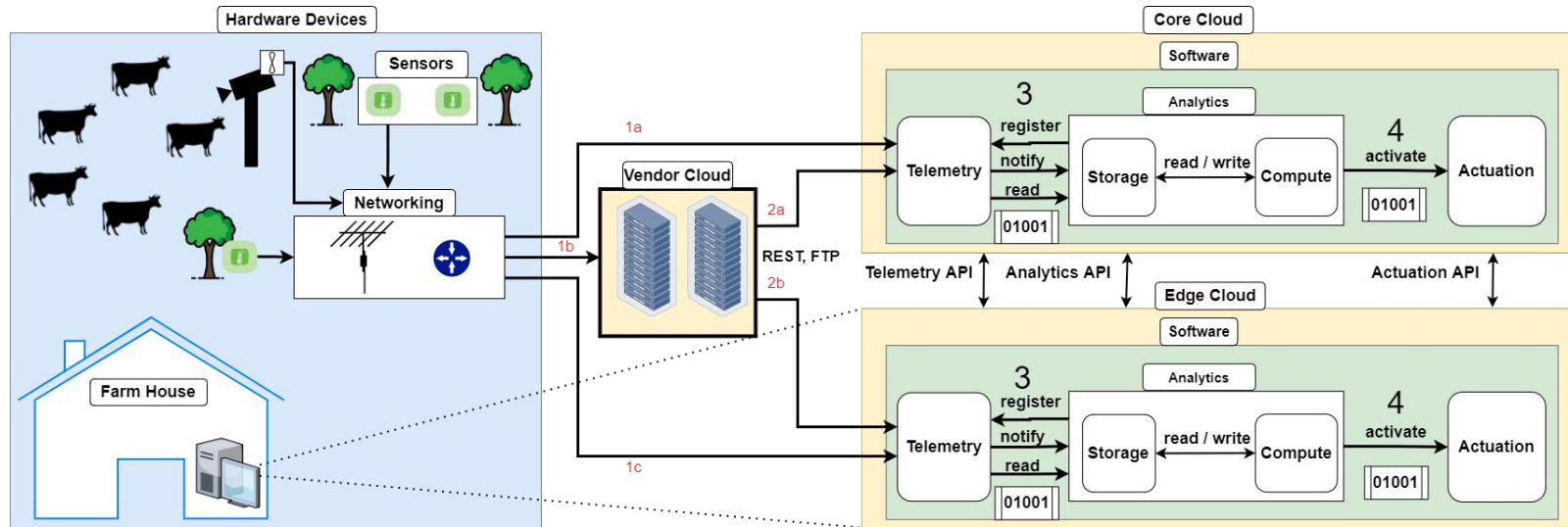

- Distilled black-box SOTA down to a single interface
- Applied strong systems approaches to new contexts
- Deployed across different farm types and cloud providers

Comosum Experiences, Insights, Limitations

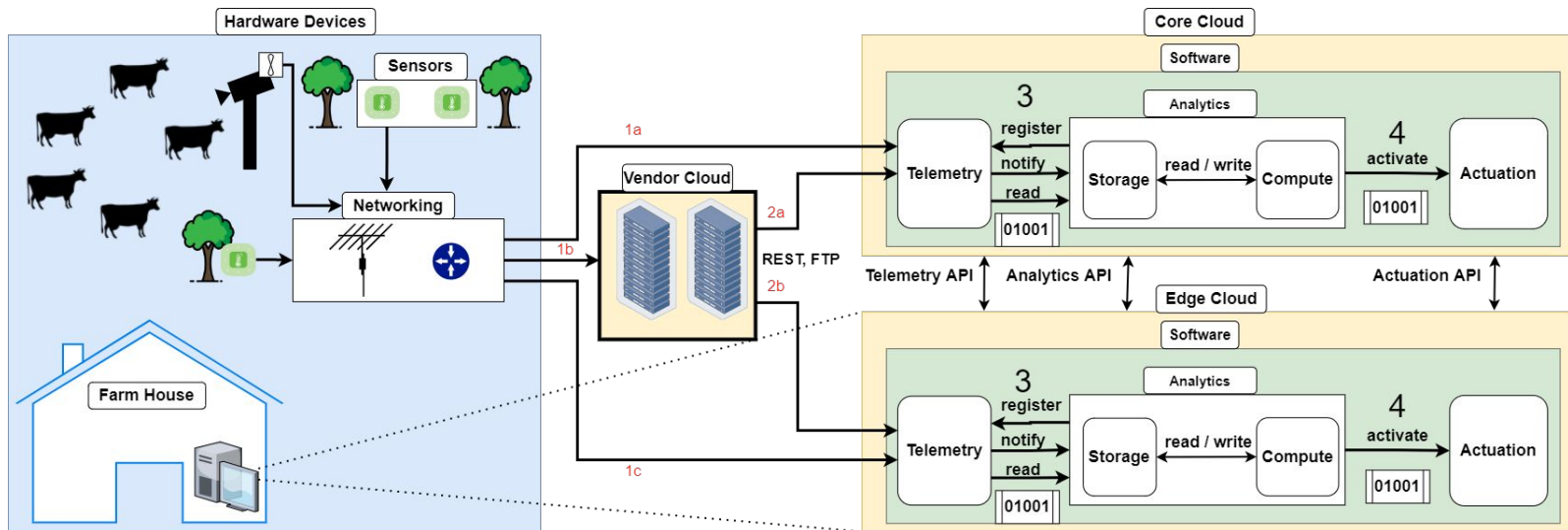

Total deployment: **18 months**
Average deployment: **223 days**
1M+ sensor readings

Comosum Experiences, Insights, Limitations



<https://github.com/Cornell-CIDA-Dev/Software-Defined-Farm>

Total deployment: **18 months**
Average deployment: **223 days**
1M+ sensor readings

Thanks



Thank You
Questions?



Gloire Rubambiza

Email: gloire@cs.cornell.edu

USENIX Slack: @gloire

Web: <https://rubambiza.github.io>

Twitter: @GloireKnowsBest